

PRODUCT SPECIFICATIONS

Elkay Circuit Chef Workstation Stainless Steel, 32-1/2" x 20-1/2" x 10" Single Bowl Undermount Sink Kit with Black Polymer Boards. Sink is manufactured from 16 gauge 304 Stainless Steel with a Lustrous Satin finish, Rear Right drain placement, and Full spray sides and bottom.

Material:	304 Stainless Steel
Special Features:	Workstation
Finish:	Lustrous Satin
Gauge:	16
Sound Deadening:	Full spray sides and bottom
Number of Bowls:	1
Sink Dimensions:	32-1/2" x 20-1/2" x 10"
Bowl 1 Dimensions:	30" x 18" x 10"
Drain Size:	3-1/2" (89mm)
Drain Location:	Rear Right
Minimum Cabinet Size:	36"
Mounting Hardware:	No
Template Included:	No
Cutout Template #:	1000005503

Template is available for download at [elkay.com](#). CAD software will be required to open the template.

Special Note: This model requires a 1/2" reveal in order for the cutting board to sit flush with the countertop.

Custom Options	
<input type="checkbox"/> Type 316 Stainless Steel	
Drain Location	
<input type="checkbox"/> Right Rear	<input type="checkbox"/> Left Rear
<input type="checkbox"/> Center	<input type="checkbox"/> Center Rear
Overflow Location	
<input type="checkbox"/> Front	<input type="checkbox"/> Rear
Alternate Punching	
<input type="checkbox"/> Faucet Model:	<input type="checkbox"/> Punch Required:
Sink Size	
<input type="checkbox"/> Bowl Depth:	<input type="checkbox"/> Drainboard Width:



Included with Product: CS3045SC Small Colander, CS30BG Bottom Grid, CS30BP Black Poly Cutting Boards, CSLPC Low Profile Colander

AMERICAN PRIDE. A LIFETIME TRADITION.

Like your family, the Elkay family has values and traditions that endure. For almost a century, Elkay has been a family-owned and operated company, providing thousands of jobs that support our families and communities.



Product Compliance: ASME A112.19.3/CSA B45.4
Buy American Act



Sinks are listed by IAPMO[®] as meeting the applicable requirements of the Uniform Plumbing Code[®], International Plumbing Code[®], and National Plumbing Code of Canada.

[Clean and Care Manual \(PDF\)](#)
[Installation Instructions \(PDF\)](#)
[Warranty \(PDF\)](#)

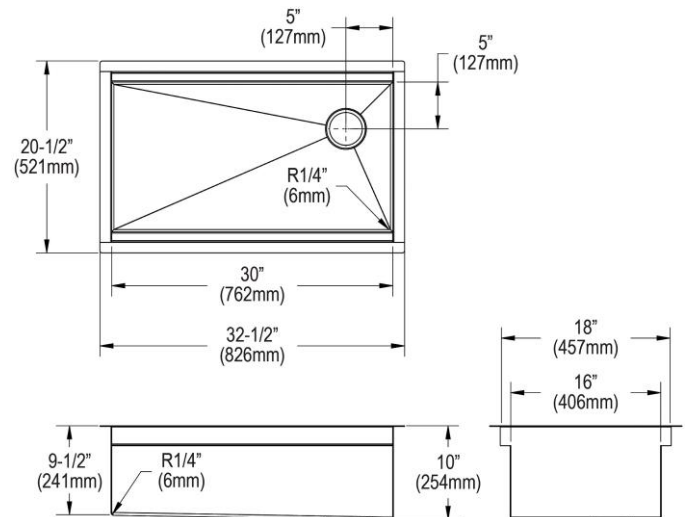

PART: _____ QTY: _____

PROJECT: _____

CONTACT: _____

DATE: _____

NOTES: _____

APPROVAL: _____

In keeping with our policy of continuing product improvement, Elkay reserves the right to change product specifications without notice. Please visit [elkay.com](#) for the most current version of Elkay product specification sheets. This specification describes an Elkay product with design, quality, and functional benefits to the user. When making a comparison of other producers' offerings, be certain these features are not overlooked.

Installation Profile:

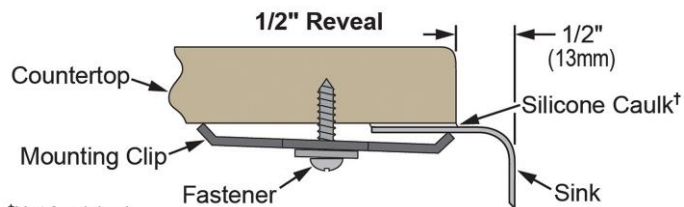

†Not furnished
Designed to affix to the underside of any solid surface countertop.

In keeping with our policy of continuing product improvement, Elkay reserves the right to change product specifications without notice. Please visit elkay.com for the most current version of Elkay product specification sheets. This specification describes an Elkay product with design, quality, and functional benefits to the user. When making a comparison of other producers' offerings, be certain these features are not overlooked.