

**PRODUCT SPECIFICATIONS**

Elkay Sink Installation Undermount Support Kit 25" Long Rails.  
Overall dimensions are 25" x 1-1/2" x 2". Made of Aluminum.

<b>Material:</b>	Aluminum
<b>Dimensions:</b>	25" x 1-1/2" x 2"
<b>Shipping Weight:</b>	2 lbs.

- Can be cut to the desired length as required.
- Designed to support the sink from the cabinet wall.

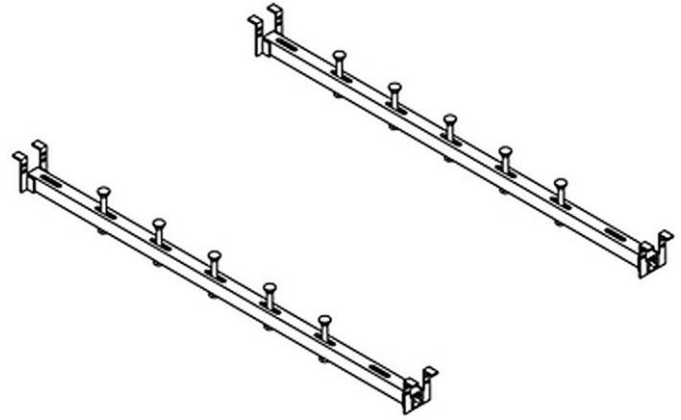

AMERICAN PRIDE. A LIFETIME TRADITION.  
Like your family, the Elkay family has values and traditions that endure. For almost a century, Elkay has been a family-owned and operated company, providing thousands of jobs that support our families and communities.



**Product Compliance:** BUY AMERICAN ACT

- [Clean and Care Manual \(PDF\)](#)
- [Installation Instructions \(PDF\)](#)
- [Warranty \(PDF\)](#)

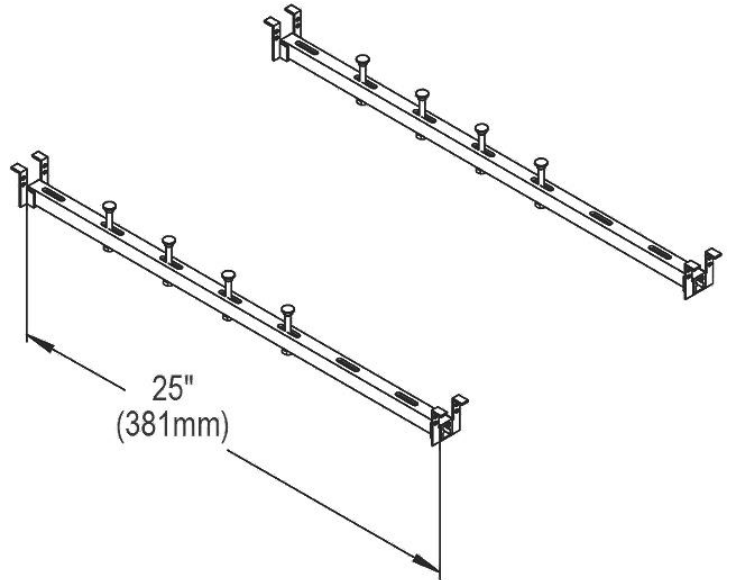

PART: \_\_\_\_\_ QTY: \_\_\_\_\_

PROJECT: \_\_\_\_\_

CONTACT: \_\_\_\_\_

DATE: \_\_\_\_\_

NOTES: \_\_\_\_\_

APPROVAL: \_\_\_\_\_

*In keeping with our policy of continuing product improvement, Elkay reserves the right to change product specifications without notice. Please visit [elkay.com](http://elkay.com) for the most current version of Elkay product specification sheets. This specification describes an Elkay product with design, quality, and functional benefits to the user. When making a comparison of other producers' offerings, be certain these features are not overlooked.*